

# Compact Performance

Safety Relief Valves

Series 437

Series 459

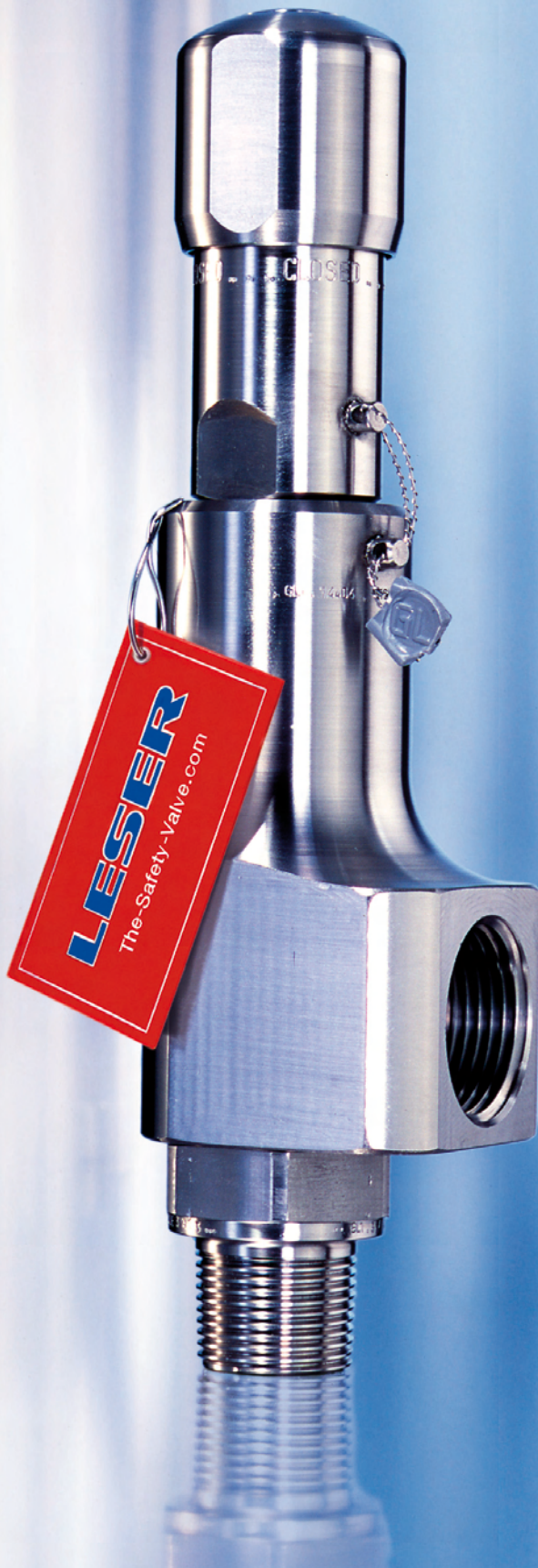

# CATALOG

**LESER**

The-Safety-Valve.com

## Product group

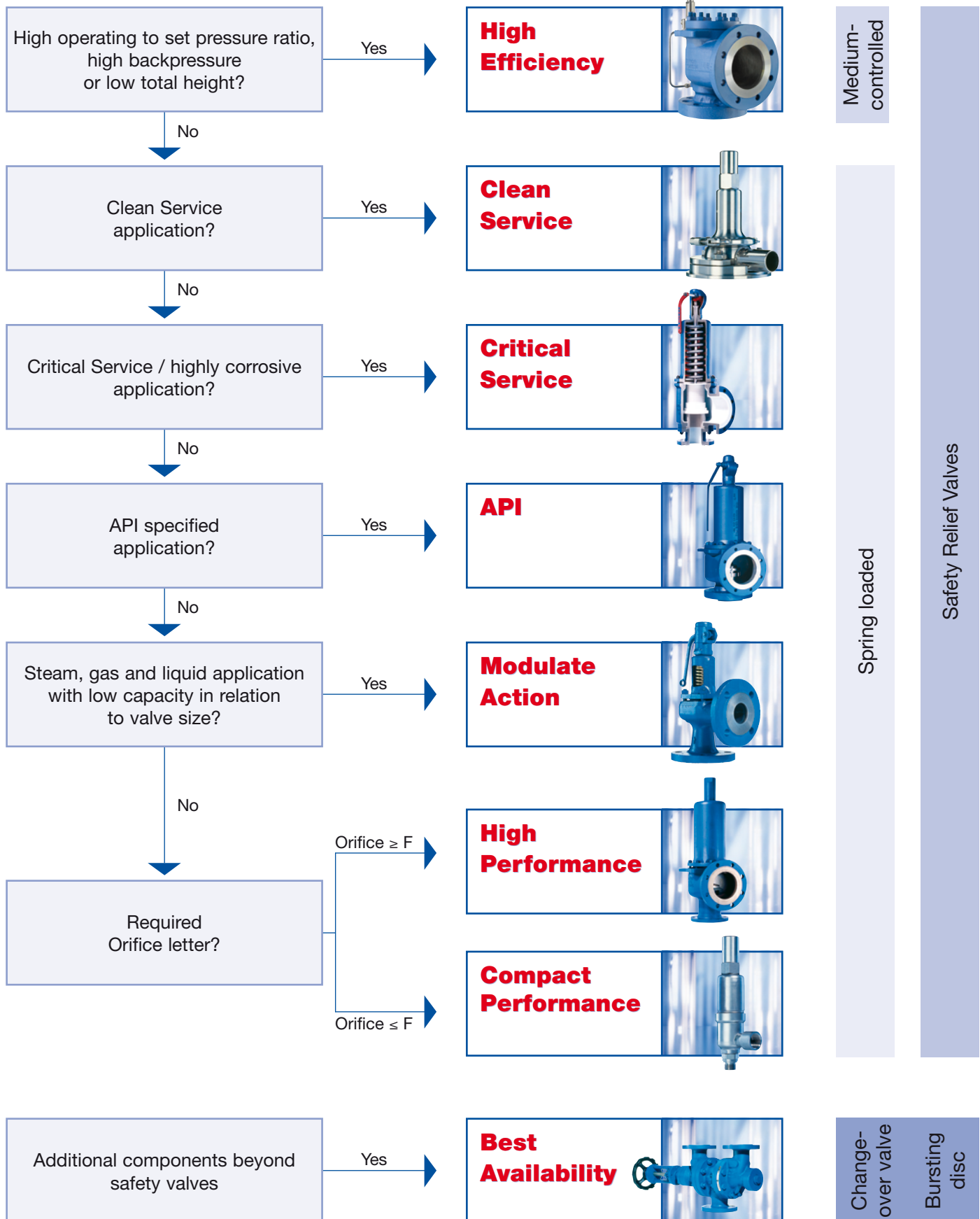

Overview	Page
<b>General</b>	<b>2</b>
Valve finder	2
Applications, General design features	4
<b>LESER Type</b>	
<b>Type 437, 438, 439</b>	<b>7</b>
<b>Type 437</b>	
<b>Materials</b>	
• Available designs	8
• Available designs – materials	9
<b>Article numbers</b>	10
<b>Dimensions and weights</b>	
• Metric Units [Threaded connection]	11
• Metric Units [Flanged connection]	12
<b>Pressure temperature ratings</b>	
• Metric Units	13
<b>Article numbers – Type 438</b>	14
<b>Article numbers – Type 439</b>	15
<b>Available options – Type 437, 438, 439</b>	16

LESER Type	Page
<b>Type 459, 459 HDD, 462, 462 HDD</b>	<b>17</b>
<b>Type 459</b>	
<b>Materials</b>	
• Available designs	18
• Available designs – materials	19
<b>Article numbers</b>	20
<b>Dimensions and weights</b>	
• Metric Units [Threaded connection]	21
• Metric Units [Flanged connection]	22
<b>Pressure temperature ratings</b>	
• Metric Units	23
<b>Article numbers – Type 459 HDD</b>	24
<b>Article numbers – Type 462</b>	25
<b>Article numbers – Type 462 HDD</b>	26
<b>Available options – Type 459, 459 HDD, 462, 462 HDD</b>	27

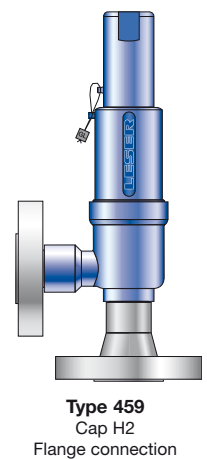
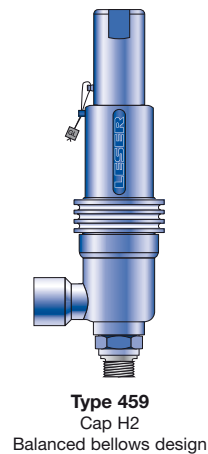
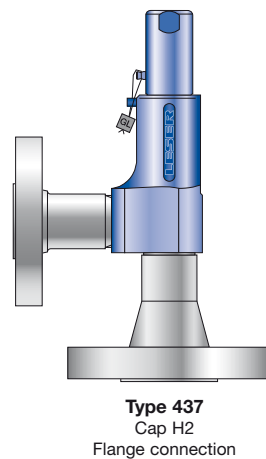
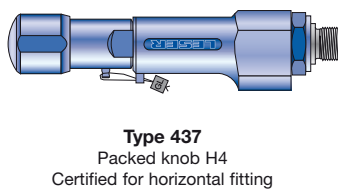
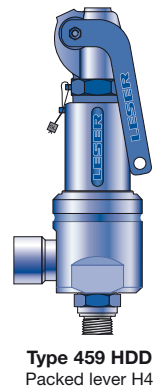
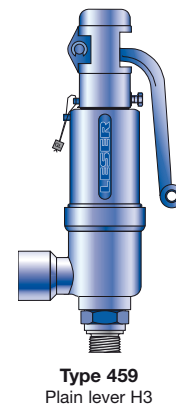
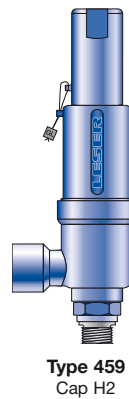
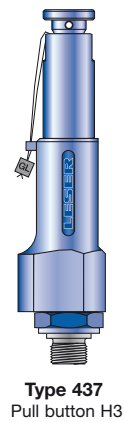
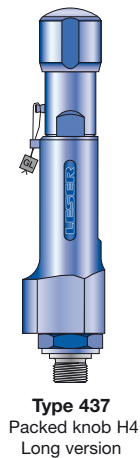
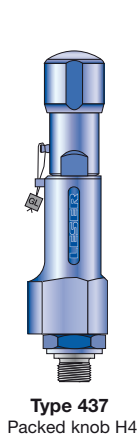

## LESER – Compact Performance Safety Valves

This product group stands for

- ✓ Compact dimensions with high capacity relative to the safety valve size
- ✓ Great variety of threaded and flanged connections
- ✓ Wide pressure range

### LESER's Compact Performance Safety Valves

- Are designed to meet all industrial applications up to F orifice
- Open rapidly with an overpressure of max. 5 % (Series 459) resp. 10 % (Series 437) to the full design lift.
- Have a maximum blowdown of minus 10 % for steam / gas service and minus 20 % for liquid service.
- Are developed in a close cooperation with plant engineers and service specialists.
- Serve for protection of processes and equipment.
- Are approved by all important approval organisations worldwide which ensures the worldwide applicability e. g.:

- European Community: CE-marking according to the Pressure Equipment Directive (PED) 97/23/EC and EN ISO 4126-1
- USA: UV-stamp according to ASME Section VIII Division 1, National Board certified capacities
- Germany: VdTÜV approval according to PED, EN ISO 4126-1, TÜV SV 100 and AD 2000-Merkblatt A2
- Canada: Canadian Registration Number according to the requirements of particular provinces
- China: AQSIQ based on the approval according to ASME Section VIII Division 1 and AD 2000-Merkblatt A2

Furthermore, all LESER Compact Performance Safety Valves are designed, marked, produced and approved according to the requirements of the following regulations (directives, codes, rules and standards).

EN ISO 4126-7, EN 12266-1 / -2, ISO 7-1 threads, ISO 228 threads, DIN EN 1092 Part I and II flanging ASME PTC 25, ASME-Code Sec. II, ASME B 16.34, ASME B1.20.1 threads and ASME B16.5 flanging, API Std. 527, API RP 576 AD 2000-Merkblatt A4, AD 2000-Merkblatt HP0, TRD 110, TRD 421, TRD 721

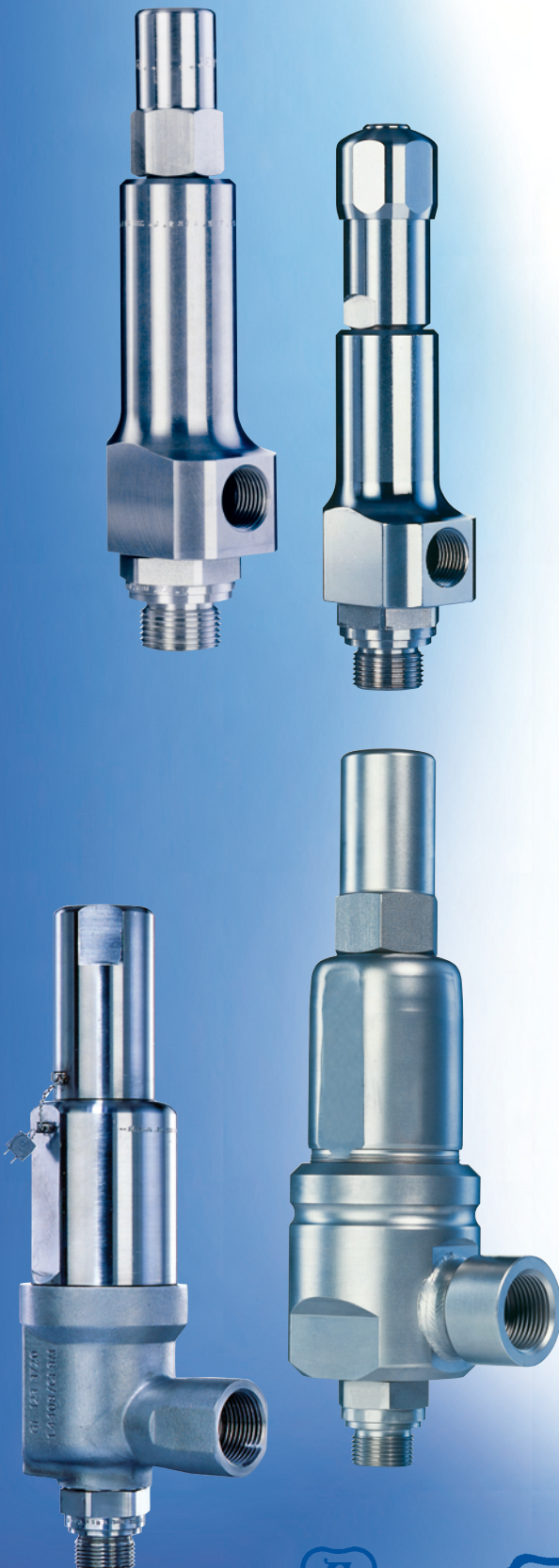

## Applications

### LESER – Compact Performance Safety Valves

offer ultimate protection against unallowable overpressures in all applications for steam, gases and liquids where smaller capacities are required.

Typical applications for LESER Compact Performance Safety Valves are:

- Air / gas compressors and pumps
- Technical gases and CO<sub>2</sub> plants
- Cylinder filling stations
- Chemical equipment and piping
- Pressure vessels and piping systems containing gas, air, liquid or steam
- LPG / LNG terminals, carriers etc.
- Cryogenic systems and oxygen applications
- Thermal relief
- High pressure extraction plants

## General Design Features

### LESER's Compact Performance Safety Valves

cover a large variety of types, materials and options to fit any application:

- Connection sizes from  $\frac{3}{8}$ " to 1  $\frac{1}{2}$ " and 5 orifices (D through F) provide high suitability to the application
- Threaded connections, male and female, according to all international standards guarantee worldwide applicability
- Flanged connections according ANSI, DIN and JIS guarantee a worldwide applicability
- Inlet pressure ratings up to PN 700 / Class 2500 to fit all required design pressures
- 2 standard based / inlet body materials, Chrome steel and stainless steel as well as 3 standard body materials, ductile iron, steel and stainless steel can be selected according to the application
- All parts can be machined from bar materials to cover special material requirements such as Hastelloy®, Duplex, Super Duplex, Tantalum or Titanium within unrivalled lead time
- Set pressures from 0.1 to 850 bar / 1.5 to 12328 psig make Compact Performance safety valves suitable for all industrial processes
- Operating temperatures from -270 to 550 °C / -454 to 1022 °F (acc. to DIN EN) cover a wide range of applications
- One design and spring (single trim) for steam, gas and liquid applications reduces the number of spare parts and ensures low cost maintenance management
- Ringless design needs no trim adjustments for easy maintenance
- One-piece spindle reduces friction which leads to high operation accuracy
- Self-draining body design, avoids residues and reduces corrosion

### LESER's Compact Performance Safety Valves

can be customized with a great variety of options, e. g.:

- Special connections specified by the customer for optimised adaptation to the plant
- Stellite or hardened metal sealing for longer product life
- Soft seat solutions for superior tightness
- Stainless steel bellows for back pressure compensation
- Heating jackets for applications with high viscosity fluids
- Base / inlet body, body, bonnet and all internal parts can be produced in special materials exactly to meet customer specification requirements





Packed knob H4  
Conventional design

Packed knob H4  
Flanged connection



Cap H2  
Long version

# Type 437 438 439

## Safety Relief Valves – spring loaded

Content	Page
<b>Type 437</b>	
<b>Materials</b>	
• Available designs	8
• Available designs – materials	9
<b>Article numbers</b>	10
<b>Dimensions and weights</b>	
• Metric Units [Threaded connection]	11
• Metric Units [Flanged connection]	12
<b>Pressure temperature ratings</b>	
• Metric Units	13
<b>Article numbers</b>	
• Type 438	14
• Type 439	15
<b>Type 437, 438, 439</b>	
• Available Options	16

## Available designs

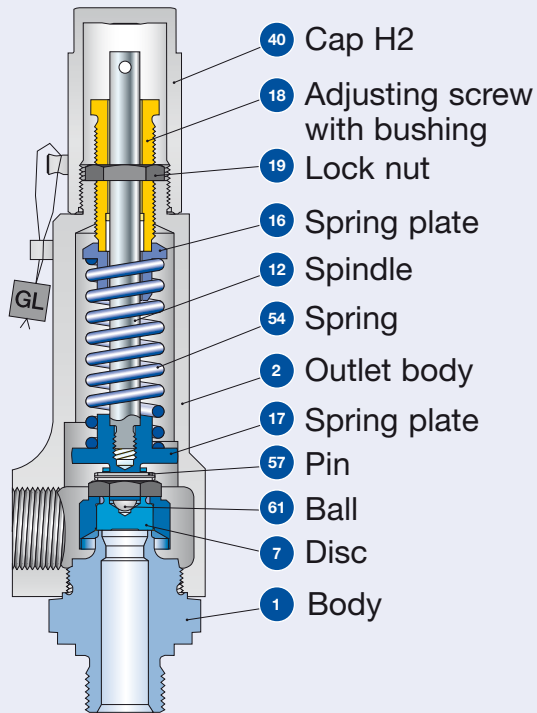

**Conventional design**  
Threaded connection

Axial needle bearing 69

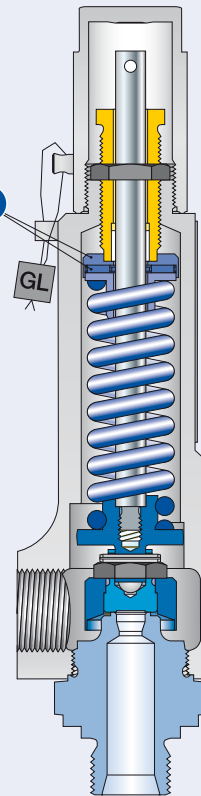

**Long version**  
Threaded connection  
only Type 437, 438

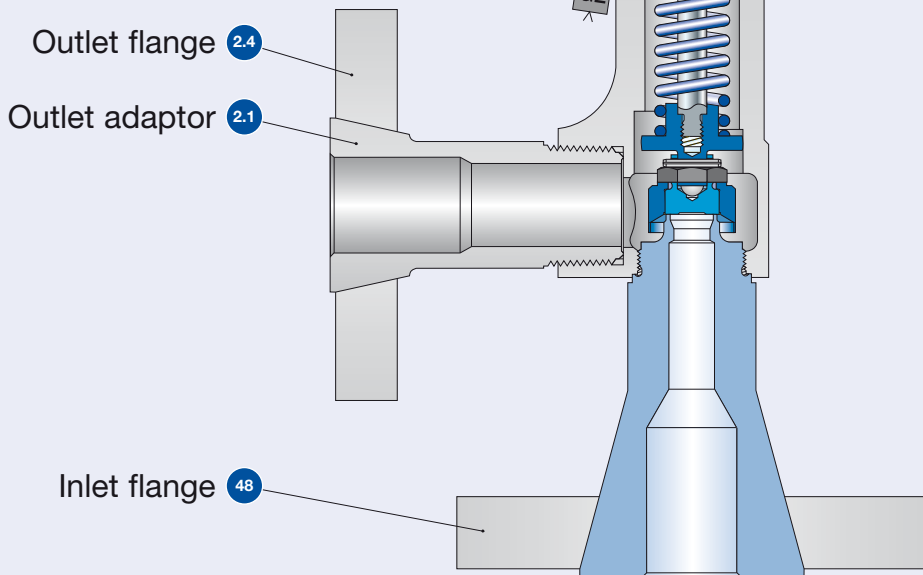

**Conventional design**  
Flange connection



## Available designs – materials

Materials						
Item	Component	Remarks	Type 4373		Type 4374	
1	Base / Inlet body	Threaded connection	1.4104 <sup>1)</sup> , 1.4404 SA 479 430 <sup>1)</sup> , SA 479 316L		1.4404 SA 479 316L	
		Flange connection	1.4404 SA 479 316L		1.4404 SA 479 316L	
		Long version	1.4104 <sup>2)</sup> , 1.4404 Stellite SA 479 430 <sup>2)</sup> , SA 479 316L Stellite		1.4404 Stellite SA 479 316L Stellite	
2	Outlet body		1.4104 SA 479 430		1.4404 SA 479 316L	
2.1	Outlet adaptor	Flange connection	1.4404 316L		1.4404 316L	
2.4	Outlet flange	Flange connection	1.4404 316L		1.4404 316L	
7	Disc		1.4122 Hardened stainless steel		1.4404 SA 316L	
		Long version	d <sub>0</sub> 6: 1.4404 Stellite d <sub>0</sub> 6: 316L Stellite	d <sub>0</sub> 10: 1.4122 d <sub>0</sub> 10: HSS	d <sub>0</sub> 6: 1.4404 Stellite d <sub>0</sub> 6: 316L Stellite	d <sub>0</sub> 10: 1.4404 d <sub>0</sub> 10: 316L
12	Spindle <sup>3)</sup>		1.4021 420		1.4571 316Ti	
		Long version	1.4571 316Ti		1.4571 316Ti	
16/17	Spring plate <sup>3)</sup>		1.4104 Chrome steel		1.4404 316L	
		Long version	1.4404 316L		1.4404 316L	
18	Adjusting screw with bushing		1.4104 Chrome steel	PTFE PTFE	1.4404 316L	PTFE PTFE
19	Lock nut		1.0718 Steel		1.4404 316L	
40	Cap H2		1.0718 Steel		1.4404 316L	
48	Inlet flange	Flange connection	1.4404 316L		1.4404 316L	
54	Spring		1.4310 Stainless steel		1.4310 Stainless steel	
57	Pin		1.4310 Stainless steel		1.4310 Stainless steel	
61	Ball		1.3541 Hardened stainless steel		1.4401 316	
69	Axial needle bearing	Long version	1.4404 316L		1.4404 316L	

<sup>1)</sup> Only for male thread DIN ISO 228-1 G<sup>3</sup>/<sub>8</sub>, G<sup>1</sup>/<sub>2</sub>, G<sup>3</sup>/<sub>4</sub> (Option Codes V49, V54, V55).

<sup>2)</sup> Only for d<sub>0</sub> 10 with male thread DIN ISO 228-1 G<sup>3</sup>/<sub>8</sub>, G<sup>1</sup>/<sub>2</sub>, G<sup>3</sup>/<sub>4</sub> (Option Codes V49, V54, V55).

<sup>3)</sup> The items 12 and 17 are combined to one unit.

### Please notice:

- Modifications reserved by LESER.
- LESER can upgrade materials without notice.
- Every part can be replaced by other material acc. to customer specification.

## Article numbers

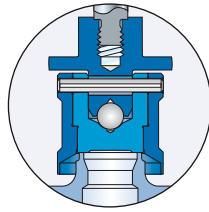

Metal seat

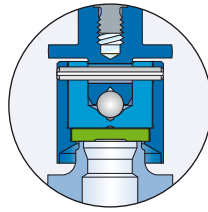

Disc with sealing plate

### Article numbers

	Conventional design		Long version	
Actual Orifice diameter $d_o$ [mm]	10	6	10	
Actual Orifice area $A_o$ [mm <sup>2</sup> ]	78,5	28,3	78,5	
Actual Orifice diameter $d_o$ [inch]	0,394	0,236	0,394	
Actual Orifice area $A_o$ [inch <sup>2</sup> ]	0,122	0,044	0,122	
<b>Base / Inlet body material: 1.4104 (430)</b>				
<b>H2</b>	Art.-No. <b>4373.</b>	<b>2602</b>	<b>2622</b>	<b>2612</b>
<b>H3</b>	Art.-No. <b>4373.</b> $p_{max.} = 16 \text{ bar}_g$	<b>2603</b>	-	-
<b>H4</b>	Art.-No. <b>4373.</b>	<b>2604</b>	<b>2624</b>	<b>2614</b>
$p$ [bar <sub>g</sub> ]	S/G/L 0,1 – 93	S/G 180 – 365	S/G/L 93 – 180	
$p$ [psig]	S/G/L 1,5 – 1349	S/G 2611 – 5294	S/G/L 1349 – 2611	
<b>Base / Inlet body material: 1.4404 (316L)</b>				
<b>H2</b>	Art.-No. <b>4374.</b>	<b>3142</b>	<b>3122</b>	<b>3152</b>
<b>H4</b>	Art.-No. <b>4374.</b>	<b>3144</b>	<b>3124</b>	<b>3154</b>
$p$ [bar <sub>g</sub> ]	S/G/L 0,1 – 68	S/G 180 – 330	S/G/L 68 – 180	
$p$ [psig]	S/G/L 1,5 – 986	S/G 2611 – 4786	S/G/L 986 – 2611	

## Dimensions and weights – Metric Units

### Threaded connections

Size Outlet body	Conventional design			Long version					
	1/2"	3/4"	1"	1/2"	3/4"	1"	1/2"	3/4"	1"
Actual Orifice diameter d <sub>0</sub> [mm]	10	10	10	6	6	6	10	10	10
Actual Orifice area A <sub>0</sub> [mm <sup>2</sup> ]	78,5	78,5	78,5	28,3	28,3	28,3	78,5	78,5	78,5
Weight [kg]	1,2	1,6	1,6	1,4	2,1	2,1	1,4	2,1	2,1
Required installation diameter [mm]	65	80	80	65	80	80	65	80	80

### Inlet thread "Female"

Size outlet body	Conventional design			Long version							
	1/2"	3/4"	1"	1/2"	3/4"	1"	1/2"	3/4"	1"		
<b>Center to face [mm]</b>											
DIN ISO 228-1 ISO 7-1/BS 21 ASME B1.20.1	G Rc NPT	Inlet 1/2" a	46	46	49	46	46	49	46	46	49
		Inlet 3/4", 1" a	56	56	59	56	56	59	56	56	59
		Outlet b	30	37	37	30	37	37	30	37	37
<b>Height [mm]</b>											
		Inlet 1/2" H max.	209	209	212	230	230	233	230	230	233
		Inlet 3/4", 1" H max.	219	219	222	240	240	243	240	240	243

### Inlet thread "Male"

Size outlet body	Conventional design			Long version							
	1/2"	3/4"	1"	1/2"	3/4"	1"	1/2"	3/4"	1"		
<b>Center to face [mm]</b>											
DIN ISO 228-1 ISO 7-1/BS 21 ASME B1.20.1	G R NPT	Inlet a	33	33	36	33	33	36	33	33	36
		Outlet b	30	37	37	30	37	37	30	37	37
		Inlet a	31	31	34	31	31	34	31	31	34
		Outlet b	30	37	37	30	37	37	30	37	37
<b>Height [mm]</b>											
Size inlet thread	Conventional design				Long version						
	3/8"	1/2"	3/4"	1"	3/8"	1/2"	3/4"	1"			
DIN ISO 228-1	G	H max.	208	210	212	217	229	231	233	238	
ISO 7-1/BS 21	R	H max.	–	213	214	220	–	234	235	241	
ASME B1.20.1	NPT	H max.	–	216	216	224	–	237	237	245	

### Length of screwed end "c" [mm]

Size inlet thread	Conventional design				Long version			
	3/8"	1/2"	3/4"	1"	3/8"	1/2"	3/4"	1"
DIN ISO 228-1	G	12	14	16	18			
ISO 7-1/BS 21	R	–	19	20	23			
ASME B1.20.1	NPT	–	22	22	27			

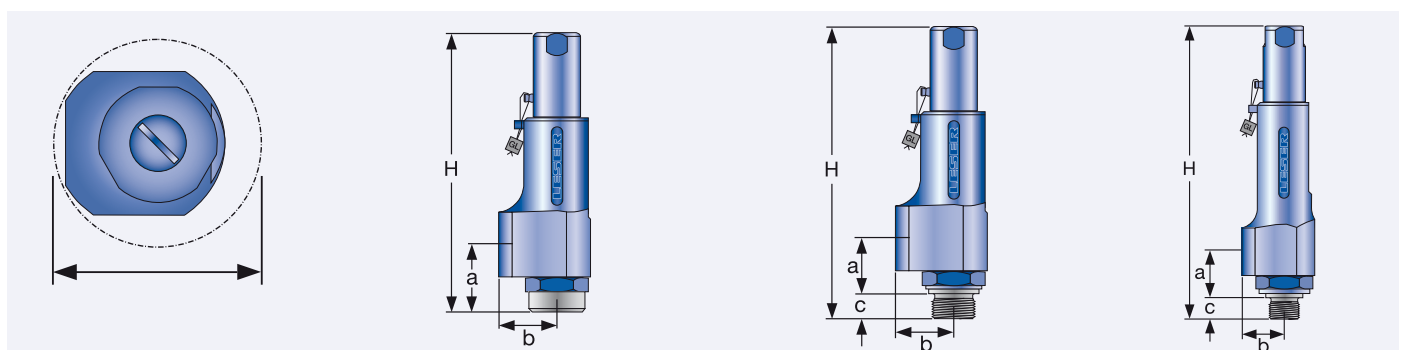

Required installation diameter

Conventional design – Female thread

Conventional design – Male thread

Long version – male thread

## Dimensions and weights – Metric Units

### Flanged connection

		Conventional design		Long version	
Actual Orifice diameter $d_0$ [mm]		10		6	10
Actual Orifice area $A_0$ [mm <sup>2</sup> ]		78,5		28,3	78,5
<b>DIN EN 1092-1</b>					
<b>Flange rating class PN 40</b>					
<b>Center to face</b>	[mm]	Inlet a	100	100	100
		Outlet b	100	100	100
<b>Height</b>	[mm]	H max.	263	284	284
<b>Flange rating class <math>\geq</math> PN 160</b>					
<b>Center to face</b>	[mm]	Inlet a	103	103	103
		Outlet b	100	100	100
<b>Height</b>	[mm]	H max.	266	287	287
<b>ASME B 16.5</b>					
<b>Flange rating class 150</b>					
<b>Center to face</b>	[mm]	Inlet a	100	100	100
		Outlet b	100	100	100
<b>Height</b>	[mm]	H max.	263	284	284
<b>Flange rating class <math>\geq</math> 300</b>					
<b>Center to face</b>	[mm]	Inlet a	103	103	103
		Outlet b	100	100	100
<b>Height</b>	[mm]	H max.	266	287	287

**Note** The outlet dimension b can differ at special combinations of nominal diameter and pressure range if flanged connections are used at the inlet and outlet. Special dimensions are possible. More information at [sales@leser.com](mailto:sales@leser.com)

### Weight

To calculate the total weight use the formula:  $m_T = m_N + m_F(\text{Inlet}) + m_F(\text{Outlet})$

<b>Weight net</b> (without inlet and outlet flange)	[kg]	$m_N$	2,4	2,8	2,8
--	------	-------	-----	-----	-----

### Flange dimensions

		DIN EN 1092-1 / Flange rating PN						ASME B16.5 / Flange rating					
		Size						Size					
		40	100	160	250	320	400	150	300	600	900	1500	2500
<b>DN 15</b>		<b>NPS 1/2"</b>											
Flange thickness	[mm] s	18	-	22	28	28	30	14	18	18	26	26	30,2
Weight slip on flange	[kg] $m_F$	0,8	-	1,2	2,5	2,5	3,6	0,6	0,9	0,9	2,1	2,1	3
<b>DN 20</b>		<b>NPS 3/4"</b>											
Flange thickness	[mm] s	20	22	-	-	-	-	15	18	18	25,4	25,4	32
Weight slip on flange	[kg] $m_F$	1,1	1,3	-	-	-	-	0,8	1,4	1,4	2,3	2,3	3,5
<b>DN 25</b>		<b>NPS 1"</b>											
Flange thickness	[mm] s	22	-	26	30	36	40	17	21,5	21,5	32,5	32,5	40
Weight slip on flange	[kg] $m_F$	1,3	-	2,6	3,5	5	7,5	1	2,1	2,1	4,1	4,1	5,1

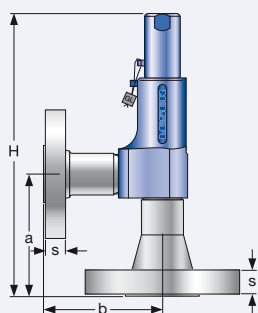

Conventional design

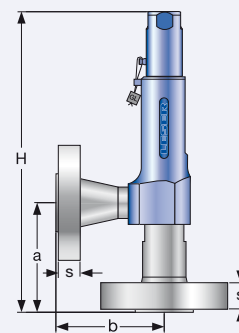

Long version

## Pressure temperature ratings

Metric Units									
Actual Orifice diameter $d_o$ [mm]		6				10			
Actual Orifice area $A_o$ [mm <sup>2</sup> ]		28,3				78,5			
Body material: 1.4104 (430)									
Base / Inlet Body	Connection size	$\frac{3}{8}$ "	$\frac{1}{2}$ "	$\frac{3}{4}$ "	1"	$\frac{3}{8}$ "	$\frac{1}{2}$ "	$\frac{3}{4}$ "	1"
	Pressure rating	PN 400				PN 320			
Outlet body	Pressure rating	PN 160				PN 160			
Minimum set pressure	p [bar <sub>g</sub> ]	180 [only S/G]				0,1			
Maximum set pressure	p [bar <sub>g</sub> ]	365 [only S/G]				16 [only H3] 180			
Temperature acc. to DIN EN	min. [°C]	-10				-10			
	max. [°C]	+220				+220			
Temperature acc. to ASME	min. [°C]	-29				-29			
	max. [°C]	+220				+220			
Body material: 1.4404 (316L)									
Base / Inlet Body	Connection size	$\frac{3}{8}$ "	$\frac{1}{2}$ "	$\frac{3}{4}$ "	1"	$\frac{3}{8}$ "	$\frac{1}{2}$ "	$\frac{3}{4}$ "	1"
	Pressure rating	PN 400				PN 320			
Outlet body	Pressure rating	PN 160				PN 160			
Minimum set pressure	p [bar <sub>g</sub> ]	180 [only S/G]				0,1			
Maximum set pressure	p [bar <sub>g</sub> ]	365 [only S/G]				180			
Temperature acc. to DIN EN	min. [°C]	-270				-270			
	max. [°C]	+280				+280			
Temperature acc. to ASME	min. [°C]	-268				-268			
	max. [°C]	+280				+280			

## Article numbers

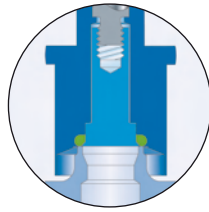

O-ring disc

### Article numbers

	Conventional design	Long version
Actual Orifice diameter $d_0$ [mm]	10	10
Actual Orifice area $A_0$ [mm <sup>2</sup> ]	78,5	78,5
Actual Orifice diameter $d_0$ [inch]	0,394	0394
Actual Orifice area $A_0$ [inch <sup>2</sup> ]	0,122	0,122
<b>O-ring material</b>	NBR "N" J30	NBR "N" J30
	CR "K" J21	CR "K" J21
	EPDM "D" J22	EPDM "D" J22
	FKM "L" J23	FKM "L" J23
	FFKM "C" J20	FFKM "C" J20

#### Base / Inlet body material: 1.4104 (430)

<b>H2</b>	Art.-No. <b>4383.</b>	<b>2862</b>	<b>2872</b>
<b>H3</b>	Art.-No. <b>4383.</b> $p_{max} = 16 \text{ bar}_g$	<b>2863</b>	-
<b>H4</b>	Art.-No. <b>4383.</b>	<b>2864</b>	<b>2874</b>
p [bar <sub>g</sub> ]	S/G/L	<b>5 – 93</b>	<b>93 – 180</b>
p [psig]	S/G/L	<b>72,5 – 1349</b>	<b>1349 – 2611</b>

#### Base / Inlet body material: 1.4404 (316L)

<b>H2</b>	Art.-No. <b>4384.</b>	<b>2982</b>	<b>2992</b>
<b>H4</b>	Art.-No. <b>4384.</b>	<b>2984</b>	<b>2994</b>
p [bar <sub>g</sub> ]	S/G/L	<b>5 – 68</b>	<b>68 – 180</b>
p [psig]	S/G/L	<b>72,5 – 986</b>	<b>986 – 2611</b>

## Article numbers

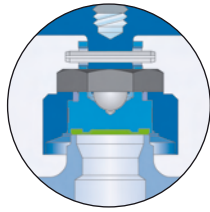

Vulcanized soft seat

Article numbers		
Actual Orifice diameter $d_o$ [mm]		10
Actual Orifice area $A_o$ [mm <sup>2</sup> ]		78,5
Actual Orifice diameter $d_o$ [inch]		0,394
Actual Orifice area $A_o$ [inch <sup>2</sup> ]		0,122
<b>Soft seal material</b>		NBR "N" J30
		CR "K" J21
		EPDM "D" J22
		FKM "L" J23
		FFKM "C" J20
Base / Inlet body material: 1.4104 (430)		
<b>H2</b>	Art.-No. <b>4393.</b>	<b>2882</b>
<b>H3</b>	Art.-No. <b>4393.</b> $p_{max} = 10 \text{ bar}_g$	<b>2883</b>
<b>H4</b>	Art.-No. <b>4393.</b>	<b>2884</b>
$p$ [bar <sub>g</sub> ]	S/G/L	<b>0,1 – 16</b>
$p$ [psig]	S/G/L	<b>1,5 – 232</b>
Base / Inlet body material: 1.4404 (316L)		
<b>H2</b>	Art.-No. <b>4394.</b>	<b>2892</b>
<b>H4</b>	Art.-No. <b>4394.</b>	<b>2894</b>
$p$ [bar <sub>g</sub> ]	S/G/L	<b>0,1 – 16</b>
$p$ [psig]	S/G/L	<b>1,5 – 232</b>

# Type 437, 438, 439

## Available options

### Male thread

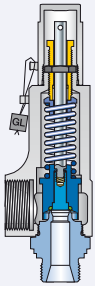

#### Type 437

**Stellited sealing surface**  
 J25: Disc stellited  
 L20: Base/inlet body

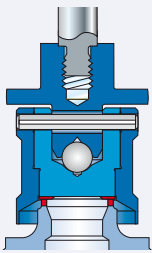

### Female thread

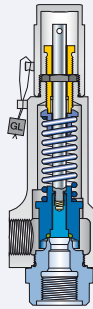

#### Type 437

**Disc with inserted sealing plate**  
 J44: PTFE-FDA "A"  
 J48: PCTFE "G"  
 J49: VESPEL-SP1 "T"

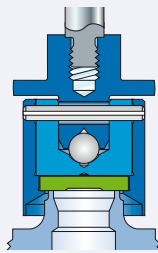

### Flanged version

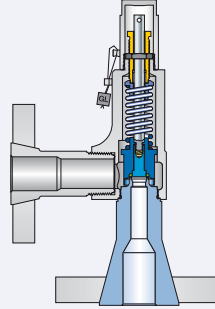

#### Type 438

**Soft seal o-ring disc**  
 J30: NBR "N"  
 J21: CR "K"  
 J22: EPDM "D"  
 J23: FKM "L"  
 J20: FFKM "C"

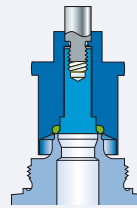

#### Type 439

**Vulcanized soft seal disc**  
 J30: NBR "N"  
 J21: CR "K"  
 J22: EPDM "D"  
 J23: FKM "L"  
 J20: FFKM "C"

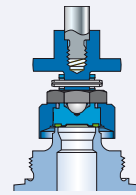

### Heating jacket H29

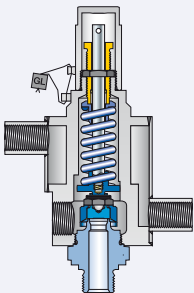

### Test gag J70: H2

### INCONEL X-750 spring X08

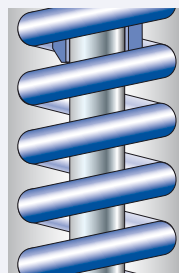

### Special material

2.4610 Hastelloy® C4  
 2.4360 Monel® 400  
 1.4462 Duplex

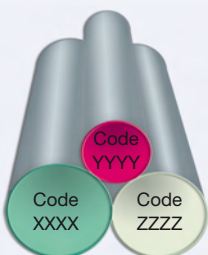



# Type 459, 462 459 HDD 462 HDD

## Safety Relief Valves – spring loaded

Plain lever H3



Cap H2

### Contents

### Page

#### Type 459

##### Materials

- Available designs 18
- Available designs – materials 19

##### Article numbers

##### Dimensions and weights

- Metric Units [Threaded connection] 21
- [Flanged connection] 22

##### Pressure temperature ratings

- Metric Units 23

##### Article numbers

- Type 459 HDD 24
- Type 462 25
- Type 462 HDD 26

##### Type 459, 459 HDD, 462, 462 HDD

- Available options 27

## Available designs

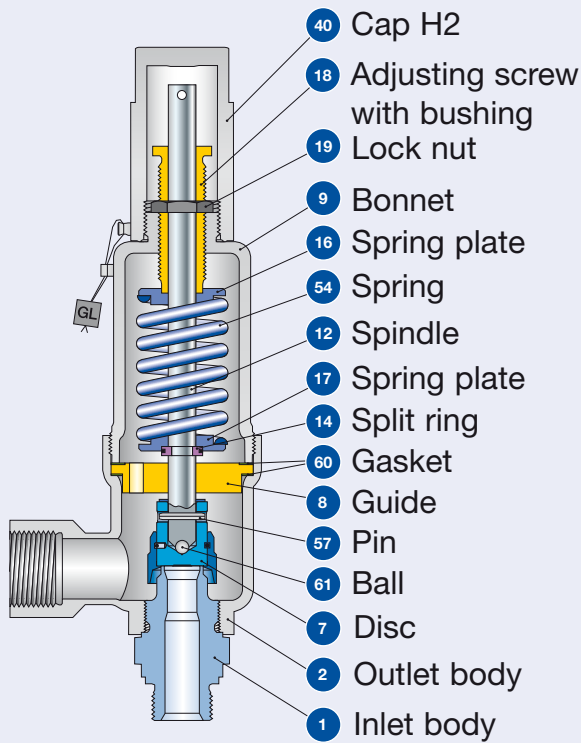

**Conventional design**  
Threaded connection

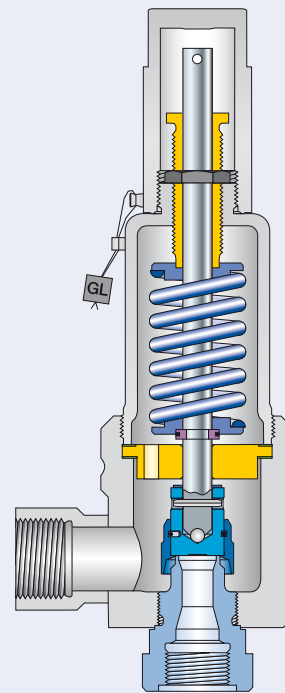

**Conventional design**  
Threaded connection

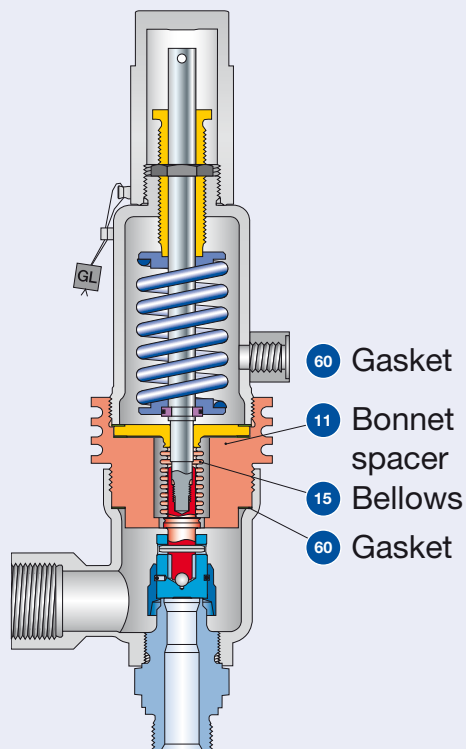

**Balanced bellows**  
Threaded connection

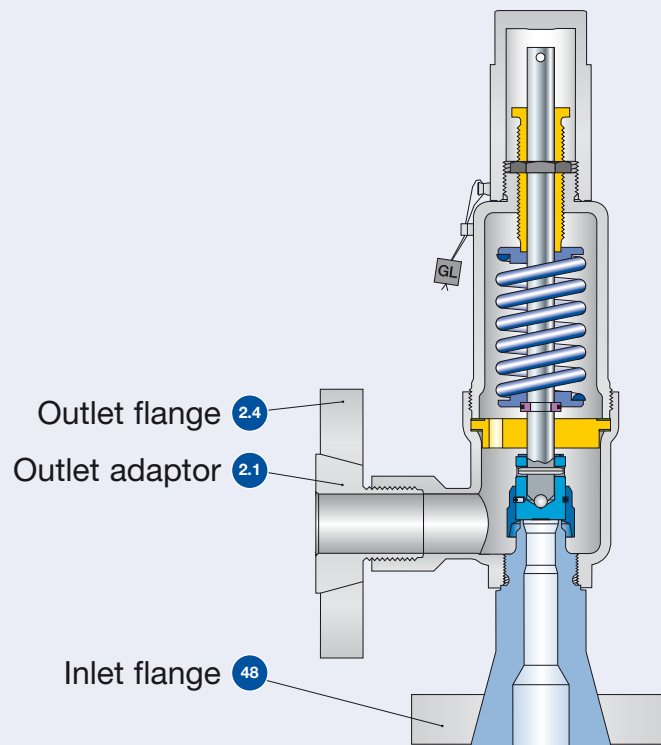

**Conventional design**  
Flange connection

## Available designs – materials

Materials									
Item	Component	Remarks	Type 4593		Type 4592		Type 4594		
1	Base / Inlet body	Threaded connection	1.4104 <sup>2)</sup> , 1.4404 SA 479 430 <sup>2)</sup> , SA 479 316L		1.4404 SA 479 316L		1.4404 SA 479 316L		
		Flange connection	1.4404 SA 479 316L		1.4404 SA 479 316L		1.4404 SA 479 316L		
2	Outlet body		0.7043 Ductile Gr. 60-40-18		1.0619 WCB		1.4408 <sup>1)</sup> CF8M <sup>1)</sup>		
2.1	Outlet adaptor	Flange connection	1.4404 316L		1.4404 316L		1.4404 316L		
2.4	Outlet flange	Flange connection	1.4404 316L		1.4404 316L		1.4404 316L		
7	Disc	Metal seat	1.4122 Hardened stainless steel		1.4122 Hardened stainless steel		1.4404 316L		
			8	Guide	1.4104 tenifer Chrome steel tenifer		1.4104 tenifer Chrome steel tenifer		1.4404 316L
Balanced bellows design	1.4404 / SA 316L Upper conn. part of balanced bellows				1.4404 / SA 316L Upper conn. part of balanced bellows		1.4404 / SA 316L Upper conn. part of balanced bellows		
9	Bonnet		0.7043 Ductile Gr. 60-40-18		1.0460 105		1.4404 316L		
		Balanced bellows design	1.4404 316L		1.4404 316L		1.4404 316L		
11	Bonnet spacer	Balanced bellows design	1.0460 Carbon steel		1.0460 Carbon steel		1.4404 316L		
12	Spindle		1.4021 420		1.4404 316L		1.4404 316L		
		Balanced bellows design	1.4404 316L		1.4404 316L		1.4404 316L		
14	Split ring		1.4104 Chrome steel		1.4104 Chrome steel		1.4404 316L		
			1.4571 SA 316Ti		1.4571 316Ti		1.4571 316Ti		
16/17	Spring plate		1.0718 Steel		1.0718 Steel		1.4404 316L		
			1.4104 Chrome steel		1.4104 Chrome steel		1.4404 316L		
18	Adjusting screw with bushung		1.4104 Chrome steel	PTFE PTFE	1.4104 Chrome steel	PTFE PTFE	1.4404 316L	PTFE PTFE	
			1.4104 Chrome steel		1.4104 Chrome steel		1.4404 316L		
40	Cap H2		1.0718 Steel		1.0718 Steel		1.4404 316L		
48	Inlet flange	Flange connection	1.4404 316L		1.4404 316L		1.4404 316L		
			54	Spring	Standard	1.1200 / 1.8159 / 1.7107 Carbon steel		1.1200 / 1.8159 / 1.7107 Carbon steel	
Optional	1.4310 Stainless steel				1.4310 Stainless steel		- -		
57	Pin		1.4310 Stainless steel		1.4310 Stainless steel		1.4310 Stainless steel		
		60	Gasket	Graphite	1.4401	Graphite	1.4401	Graphite	1.4401
Graphite	316			Graphite	316	Graphite	316		
61	Ball		1.3541 Hardened stainless steel		1.3541 Hardened stainless steel		1.4401 316		

**Please notice:**

- Modifications reserved by LESER.
- LESER can upgrade materials without notice.
- Every part can be replaced by other material acc. to customer specification.

<sup>1)</sup> Type 4594 with outlet body deep-drawn: outlet body material 1.4404 / 316L

<sup>2)</sup> only valid for male thread DIN ISO 228-1 G $\frac{3}{4}$ ", G1", G1 $\frac{1}{2}$ " (Option codes V55, V56, V57) (please note availability regarding d<sub>2</sub>)

## Article numbers

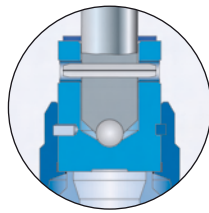

Metal seat

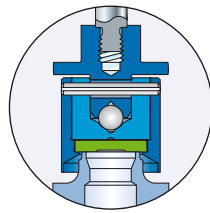

Disc with sealing plate

### Article numbers

Actual Orifice diameter $d_0$ [mm]	9	13	17,5
Actual Orifice area $A_0$ [mm <sup>2</sup> ]	63,6	133	241
Actual Orifice diameter $d_0$ [inch]	0,354	0,512	0,689
Actual Orifice area $A_0$ [inch <sup>2</sup> ]	0,099	0,206	0,374

#### Outlet body casted

Inlet body	1.4104	H2	Art.-No. 4593.	2502	2512	2522
Outlet body	0.7043	H3	Art.-No. 4593.	2503	2513	2523
Bonnet	0.7043	H4	Art.-No. 4593.	2504	2514	2524
$p$ [bar <sub>g</sub> ]		S/G/L		1,5 – 250	0,2 – 200	0,2 – 100
$p$ [psig]				21,7 – 3626	2,9 – 2901	2,9 – 1450

#### Outlet body investment casted

Inlet body	1.4404	H2	Art.-No. 4592.	2472	2482	2492
Outlet body	1.0619	H3	Art.-No. 4592.	2473	2483	2493
	(WCB)	H4	Art.-No. 4592.	2474	2484	2494
Bonnet	1.0460	H4	Art.-No. 4592.	2474	2484	2494
$p$ [bar <sub>g</sub> ]		S/G/L		1,5 – 250	0,2 – 200	0,2 – 100
$p$ [psig]				21,7 – 3626	2,9 – 2901	2,9 – 1450

#### Outlet body investment casted

Inlet body	1.4404	H2	Art.-No. 4594.	2162	2172	2182
Outlet body	1.4408	H3	Art.-No. 4594.	2163	2173	2183
	(CF8M)	H4	Art.-No. 4594.	2164	2174	2184
Bonnet	1.4404	H4	Art.-No. 4594.	2164	2174	2184
$p$ [bar <sub>g</sub> ]		S/G/L		1,5 – 250	0,2 – 200	0,2 – 100
$p$ [psig]				21,7 – 3626	2,9 – 2901	2,9 – 1450

#### Outlet body deep-drawn

All body and trim parts	1.4404	H2	Art.-No. 4594.	2552	2562	2572
		H4	Art.-No. 4594.	2554	2564	2574
$p$ [bar <sub>g</sub> ]		S/G/L		1,5 – 250	0,2 – 200	0,2 – 100
$p$ [psig]				21,7 – 3626	2,9 – 2901	2,9 – 1450

## Dimensions and weights – Metric Units

### Threaded connections

	Size Outlet body	1/2" x 1"	3/4" x 1"	1" x 1"	1/2" x 1"	3/4" x 1"	1" x 1"	3/4" x 1 1/2"	1" x 1 1/2"	1 1/4" x 1 1/2"	1 1/2" x 1 1/2"
Actual Orifice diameter d <sub>0</sub> [mm]		9	9	9	13	13	13	17,5	17,5	17,5	17,5
Actual Orifice area A <sub>0</sub> [mm <sup>2</sup> ]		63,6	63,6	63,6	133	133	133	241	241	241	241
Weight	[kg]	2,6	2,6	2,6	2,6	2,6	2,6	3,0	3,0	3,0	3,0
	Balanced bellows	[kg]	3,4	3,4	3,4	3,4	3,4	3,8	3,8	3,8	3,8
Required installation diameter	[mm]	165	165	165	165	165	165	165	165	165	165

### Inlet thread "Female"

	Size outlet body	1/2" x 1"	3/4" x 1"	1" x 1"	1/2" x 1"	3/4" x 1"	1" x 1"	3/4" x 1 1/2"	1" x 1 1/2"	1 1/4" x 1 1/2"	1 1/2" x 1 1/2"		
Actual Orifice diameter d <sub>0</sub> [mm]		9	9	9	13	13	13	17,5	17,5	17,5	17,5		
<b>Center to face / Height</b>													
<b>DIN ISO 228-1</b>	<b>G</b>	Inlet a		53	56	62	53	56	62	60	66	67	73
<b>ASME B1.20.1</b>	<b>NPT</b>	Outlet b		75	75	75	75	75	75	75	75	75	75
Center to face [mm]		H max		283	286	292	283	286	292	287	293	294	300
Height [mm]		Balanced bellows H max		315	318	324	315	318	324	319	325	326	332
<b>ISO 7-1/BS 21</b>	<b>Rc</b>	Inlet a		53	56	64	53	56	64	60	68	–	77
Center to face [mm]		Outlet b		75	75	75	75	75	75	75	75	–	75
Height [mm]		H max		283	286	294	283	286	294	287	295	–	304
		Balanced bellows H max		315	318	326	315	318	326	319	327	–	336

### Inlet thread "Male"

	Size outlet body	1"	1"	1 1/2"		
Actual Orifice diameter d <sub>0</sub> [mm]		9	13	17,5		
<b>Center to face [mm]</b>						
<b>DIN ISO 228-1</b>	<b>G</b>	Inlet 1/2" – 1" a		52	–	–
		Inlet 1" – 2" a		–	–	56
		Outlet b		75	75	75
<b>ISO 7-1/BS 21</b>	<b>R</b>	Inlet 1/2" – 1" a		49	49	–
<b>ASME B1.20.1</b>	<b>NPT</b>	Inlet 1" – 2" a		–	–	53
		Outlet b		75	75	75

### Height [mm]

		Conventional design						Balanced bellows						
Size inlet thread		1/2"	3/4"	1"	1 1/4"	1 1/2"	2"	1/2"	3/4"	1"	1 1/4"	1 1/2"	2"	
<b>DIN ISO 228-1</b>	<b>G</b>	H max.	296	298	301	303	305	–	328	330	333	335	337	–
<b>ISO 7-1/BS 21</b>	<b>R</b>	H max.	298	299	303	–	305	–	330	331	335	–	337	–
<b>ASME B1.20.1</b>	<b>NPT</b>	H max.	301	301	307	308	308	309	333	333	339	340	340	341

### Length of screwed end "c" [mm]

Size inlet thread		1/2"	3/4"	1"	1 1/4"	1 1/2"	2"
<b>DIN ISO 228-1</b>	<b>G</b>	14	16	18	20	22	–
<b>ISO 7-1/BS 21</b>	<b>R</b>	19	20	23	–	25	–
<b>ASME B1.20.1</b>	<b>NPT</b>	22	22	27	28	28	29

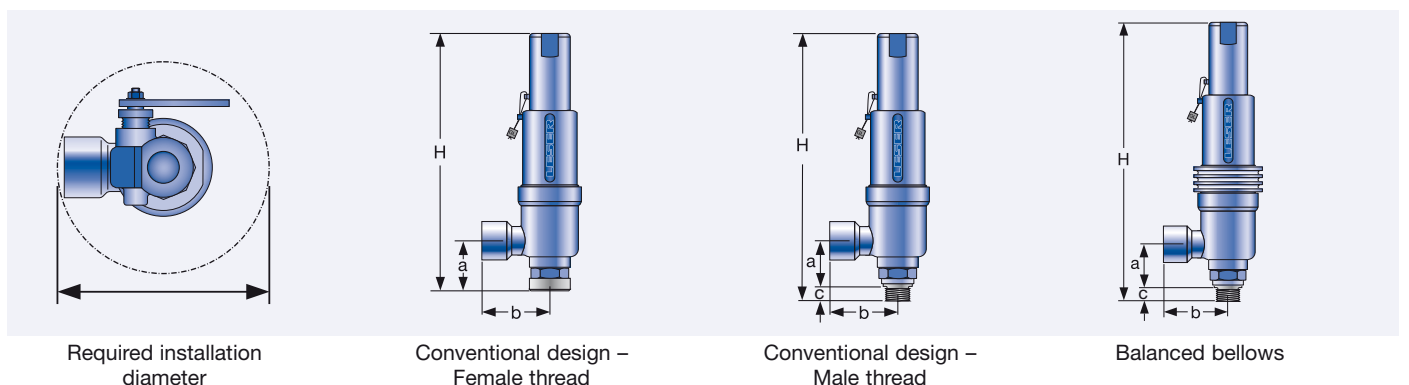

## Dimensions and weights – Metric Units

### Flanged connection

	Conventional design			Balanced bellows		
Actual Orifice diameter $d_0$ [mm]	9	13	17.5	9	13	17.5
Actual Orifice area $A_0$ [mm <sup>2</sup> ]	63,6	133	241	63,6	133	241

#### DIN EN 1092-1

#### Flange rating PN 40 – PN 400

Center to face	[mm]	Inlet a	100	100	105	100	100	105
		Outlet b	100	100	100	100	100	100
Height	[mm]	H max.	330	330	333	375	375	378

#### ASME B 16.5

#### Flange rating class 150 – 2500

Center to face	[mm]	Inlet a	100	103	105	100	100	105
		Outlet b	100	100	100	100	100	100
Height	[mm]	H max.	330	330	333	375	375	378

**Note** The outlet dimension b can differ at special combinations of nominal diameter and pressure range if flanged connections are used at the inlet and outlet. Special dimensions are possible. More information at sales@leser.com.

#### Weight

For the calculation of the total weight please use the Formular:  $W_T = W_N + W_F(\text{Inlet}) + W_F(\text{Outlet})$

Weight net	[kg]	$m_N$	2,6	2,3	3	3,8	3,8	4,2
(without inlet and outlet flange)								

#### Flange dimensions

		DIN EN 1092-1 / Flange rating PN						ASME B16.5 / Flange rating						
Size		40	100	160	250	320	400	Size	150	300	600	900	1500	2500
DN 15								NPS 1/2"						
Flange thickness	[mm] s	18	-	22	28	28	30		14	18	18	26	26	30,2
Weight slip on flange	[kg] $m_F$	0,8	-	1,2	2,5	2,5	3,6		0,6	0,9	0,9	2,1	2,1	3
DN 20								NPS 3/4"						
Flange thickness	[mm] s	20	22	-	-	-	-		15	18	18	25,4	25,4	32
Weight slip on flange	[kg] $m_F$	1,1	1,3	-	-	-	-		0,8	1,4	1,4	2,3	2,3	3,5
DN 25								NPS 1"						
Flange thickness	[mm] s	22	-	26	30	36	40		17	21,5	21,5	32,5	32,5	40
Weight slip on flange	[kg] $m_F$	1,3	-	2,6	3,5	5	7,5		1	2,1	2,1	4,1	4,1	5,1
DN 40								NPS 1 1/2"						
Flange thickness	[mm] s	21	-	23	32	-	-		22	24	24	32	-	-
Weight slip on flange	[kg] $m_F$	2,1	-	2,9	4,3	-	-		1,4	2,2	2,2	3,9	-	-

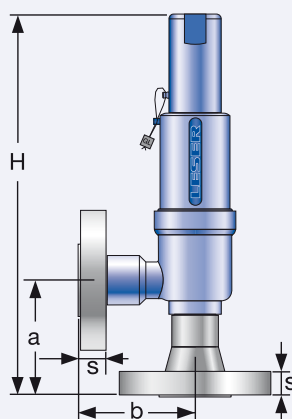

Conventional design

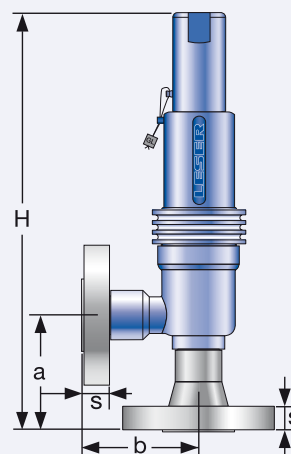

Balanced bellows

## Pressure temperature ratings – Metric Units

Metric Units												
Actual Orifice diameter $d_0$ [mm]		9			13					17,5		
Actual Orifice Area $A_0$ [mm <sup>2</sup> ]		63,6			133					241		
Body material: 1.4104 (430)				Type 4593								
Base / Inlet Body	Connection size	1/2"	3/4"	1"	1/2"	3/4"	1"	3/4"	1"	1 1/4"	1 1/2"	2"
	Pressure rating	PN 400			PN 250			PN 160				
Outlet body	Pressure rating	PN 40			PN 40			PN 40				
Minimum set pressure	p [bar <sub>g</sub> ] S/G/L	1,5			0,2			0,2				
Min. set pressure standard bellows	p [bar <sub>g</sub> ] S/G/L	3			3			3				
Min. set pressure <sup>1)</sup> high press. bellows	p [bar <sub>g</sub> ] S/G/L	40			40			40				
Maximum set pressure	p [bar <sub>g</sub> ] S/G/L	250			200			100				
Temperature acc. to DIN EN	min [°C]				-10							
	max [°C]				+300							
Temperature acc. to ASME	min [°C]				-29							
	max [°C]				+300							
Body material: 1.4404 (316L)				Type 4592								
Base / Inlet Body	Connection size	1/2"	3/4"	1"	1/2"	3/4"	1"	3/4"	1"	1 1/4"	1 1/2"	2"
	Pressure rating	PN 250 PN 500 (Option code L20)			PN 160 PN 250 (Option code L20)			PN 160				
Outlet body	Pressure rating	PN 40			PN 40			PN 40				
Minimum set pressure	p [bar <sub>g</sub> ] S/G/L	1,5			0,2			0,2				
Min. set pressure standard bellows	p [bar <sub>g</sub> ] S/G/L	3			3			3				
Min. set pressure <sup>1)</sup> high press. bellows	p [bar <sub>g</sub> ] S/G/L	40			40			40				
Maximum set pressure	p [bar <sub>g</sub> ] S/G/L	250			200			100				
Temperature acc. to DIN EN	min [°C]				-85							
	max [°C]				+400							
Temperature acc. to ASME	min [°C]				-29							
	max [°C]				+427							
Body material: 1.4404 (316L)				Type 4594								
Base / Inlet Body	Connection size	1/2"	3/4"	1"	1/2"	3/4"	1"	3/4"	1"	1 1/4"	1 1/2"	2"
	Pressure rating	PN 250 PN 500 (Option code L20)			PN 160 PN 500 (Option code L20)			PN 160				
Outlet body	Pressure rating	PN 40			PN 40			PN 40				
Minimum set pressure	p [bar <sub>g</sub> ] S/G/L	1,5			0,2			0,2				
Min. set pressure standard bellows	p [bar <sub>g</sub> ] S/G/L	3			3			3				
Min. set pressure <sup>1)</sup> high press. bellows	p [bar <sub>g</sub> ] S/G/L	40			40			40				
Maximum set pressure	p [bar <sub>g</sub> ] S/G/L	250			200			100				
Temperature acc. to DIN EN	min [°C]				-200							
	max [°C]				+400							
Temperature acc. to ASME	min [°C]				-184							
	max [°C]				+427							

<sup>1)</sup> Min. set pressure high pressure bellows = Max. pressure standard bellows.

Because there is no open bonnet for this type available, please use at a temperature of 300 °C (572 °F) refer to SAP a stainless steel bellows or a specific high temperature model without a bellows. For DIN EN applications at temperatures under -10°C please proceed according to AD-2000 Merkblatt W 10.

## Article numbers

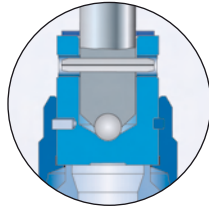

Metal seat

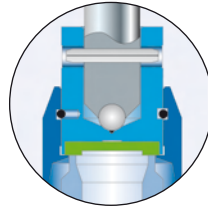

Disc with sealing plate

### Article numbers

Actual Orifice diameter $d_0$ [mm]		6 <sup>1)</sup>	9	13	
Actual Orifice area $A_0$ [mm <sup>2</sup> ]		28,3	63,9	133	
Actual Orifice diameter $d_0$ [inch]		0,236	0,354	0,512	
Actual Orifice area $A_0$ [inch <sup>2</sup> ]		0,044	0,099	0,206	
<b>Body material: 14404 (316L)</b>					
<b>All body and trim parts</b>	<b>1.4404</b>	<b>H2 Art.-No. 4594.</b>	<b>2532</b>	<b>2582</b>	<b>2592</b>
		<b>H4 Art.-No. 4594.</b>	<b>2534</b>	<b>2584</b>	<b>2594</b>
		$p$ [bar <sub>g</sub> ]	<b>420,01 – 850</b>	<b>1,5 – 420</b>	<b>0,2 – 200</b>
		$p$ [psig] S/G/L	<b>6091 – 12328</b>	<b>21,7 – 6091</b>	<b>2,9 – 2901</b>

<sup>1)</sup> The specification of the medium is necessary at liquid applications (Option Code M09).



## Article numbers

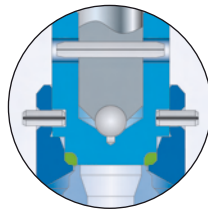

O-ring disc

### Article numbers

Actual Orifice diameter $d_0$ [mm]		9	13	17,5
Actual Orifice area $A_0$ [mm <sup>2</sup> ]		63,6	133	241
Actual Orifice diameter $d_0$ [inch]		0,354	0,512	0,689
Actual Orifice area $A_0$ [inch <sup>2</sup> ]		0,099	0,206	0,374
<b>O-ring material</b>			NBR "N" J30	
			CR "K" J21	
			EPDM "D" J22	
			FKM "L" J23	
			FFKM "C" J20	
<b>Outlet body casted</b>				
<b>Inlet body</b>	<b>1.4104</b>	<b>H2</b>	<b>Art.-No. 4623.</b>	<b>2902</b>
<b>Outlet body</b>	<b>0.7043</b>	<b>H3</b>	<b>Art.-No. 4623.</b>	<b>2903</b>
<b>Bonnet</b>	<b>0.7043</b>	<b>H4</b>	<b>Art.-No. 4623.</b>	<b>2904</b>
	p [bar <sub>g</sub> ]		S/G/L	0,5 – 250
	p [psig]			7,3 – 3626
				0,5 – 180
				0,5 – 92,5
				7,3 – 2611
				7,3 – 1342
<b>Outlet body investment casted</b>				
<b>Inlet body</b>	<b>1.4404</b>	<b>H2</b>	<b>Art.-No. 4622.</b>	<b>3772</b>
<b>Outlet body</b>	<b>1.0619</b>	<b>H3</b>	<b>Art.-No. 4622.</b>	<b>3773</b>
<b>Bonnet</b>	<b>1.0460</b>	<b>H4</b>	<b>Art.-No. 4622.</b>	<b>3774</b>
	p [bar <sub>g</sub> ]		S/G/L	0,5 – 250
	p [psig]			7,3 – 3626
				0,5 – 180
				0,5 – 92,5
				7,3 – 2611
				7,3 – 1342
<b>Outlet body investment casted</b>				
<b>Inlet body</b>	<b>1.4404</b>			
<b>Outlet body</b>	<b>1.4408</b>	<b>H2</b>	<b>Art.-No. 4624.</b>	<b>2192</b>
	<b>(CF8M)</b>			
<b>Bonnet</b>	<b>1.4404</b>	<b>H4</b>	<b>Art.-No. 4624.</b>	<b>2194</b>
	p [bar <sub>g</sub> ]		S/G/L	0,5 – 250
	p [psig]			7,3 – 3626
				0,5 – 180
				0,5 – 92,5
				7,3 – 2611
				7,3 – 1342
<b>Outlet body deep-drawn</b>				
<b>All body and trim parts</b>		<b>H2</b>	<b>Art.-No. 4624.</b>	<b>2952</b>
	<b>1.4404</b>	<b>H4</b>	<b>Art.-No. 4624.</b>	<b>2954</b>
	p [bar <sub>g</sub> ]		S/G/L	0,5 – 250
	p [psig]			7,3 – 3626
				0,5 – 180
				0,5 – 92,5
				7,3 – 2611
				7,3 – 1342

## Article numbers

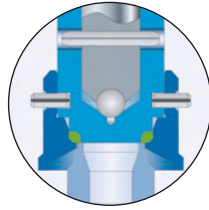

O-ring disc



### Article numbers

Actual Orifice diameter $d_0$ [mm]	9	13
Actual Orifice area $A_0$ [mm <sup>2</sup> ]	63,6	133
Actual Orifice diameter $d_0$ [inch]	0,354	0,512
Actual Orifice area $A_0$ [inch <sup>2</sup> ]	0,099	0,206

<b>O-ring material</b>	NBR	"N"	J30
	CR	"K"	J21
	EPDM	"D"	J22
	FKM	"L"	J23
	FFKM	"C"	J20

<b>Body material: 1.4404 (316L)</b>					
<b>All body and trim parts</b>	<b>1.4404</b>	<b>H2</b>	<b>Art.-No. 4624.</b>	<b>2252</b>	<b>2272</b>
		<b>H4</b>	<b>Art.-No. 4624.</b>	<b>2254</b>	<b>2274</b>
	p [bar <sub>g</sub> ]	S/G/L		<b>0,5 – 350</b>	<b>0,5 – 180</b>
	p [psig]		<b>7,3 – 5076</b>	<b>7,3 – 2611</b>	

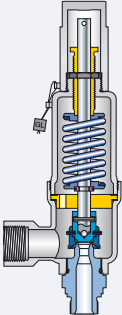
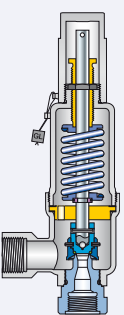
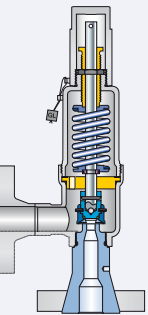
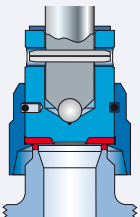
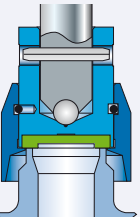
## Available Options

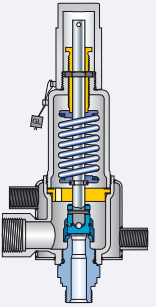
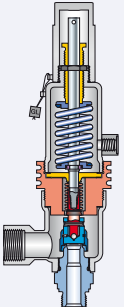
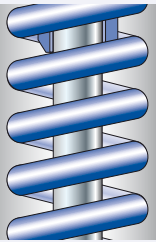
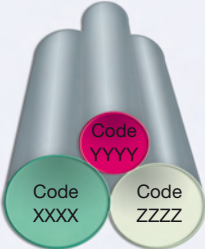
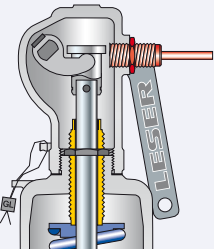
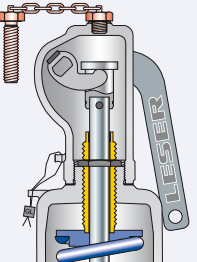
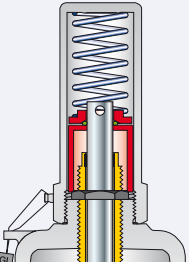
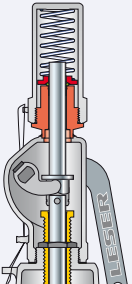
<p><b>Male thread</b></p> 	<p><b>Female thread</b></p> 	<p><b>Flanged version</b></p> 	<p><b>Solar valve</b> N80</p> <p>4592.2482 4592.2484</p>
<p><b>Type 459</b></p> <p><b>Stellited sealing surface</b> J25: Disc stellited L20: Base/inlet body</p> 	<p><b>Type 459</b></p> <p><b>Disc with inserted sealing plate</b> J44: PTFE-FDA "N" J48: PCTFE "D" J49: VESPEL-SP "K"</p> 	<p><b>Type 462</b></p> <p><b>Soft seal o-ring disc</b> J30: NBR "N" J21: CR "K" J22: EPDM "D" J23: FKM "L" J20: FFKM "C"</p> 	
<p><b>Heating jacket</b> H29</p> 	<p><b>Balanced bellows</b></p> 	<p><b>INCONEL X-750 spring</b> X08</p> 	<p><b>Special material</b> 2.4610 Hastelloy® C4 2.4360 Monel® 400 1.4462 Duplex</p> 
<p><b>Lift indicator</b> J93: Lift indicator</p> 	<p><b>Test gag</b> J69: H4 J70: H2</p> 	<p><b>O-ring-damper H2</b> J65</p> 	<p><b>O-ring-damper H4</b> J66</p> 

# LESER worldwide

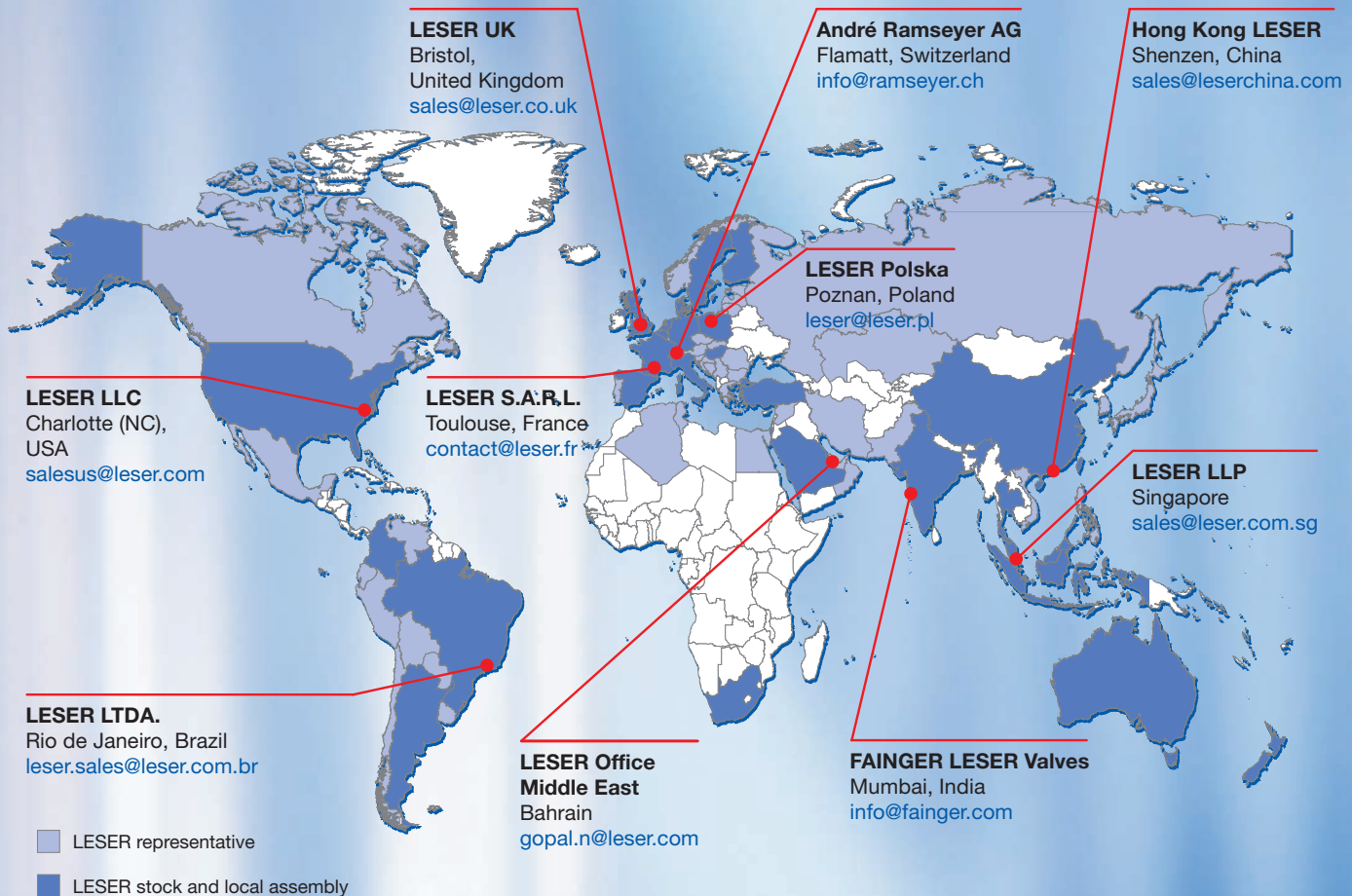

Compact Performance Catalog  
Edition July 2012/1.000  
0777.5681

# LESER

The-Safety-Valve.com

LESER GmbH & Co. KG

20537 Hamburg, Wendenstr. 133-135  
20506 Hamburg, P.O. Box 26 16 51

Fon +49 (40) 251 65-100  
Fax +49 (40) 251 65-500

E-Mail: sales@leser.com  
www.leser.com